

# ZERTIFIKAT

Zertifizierte Passivhaus-Komponente

Komponenten-ID 1894ws03 gültig bis 31. Dezember 2022

Passivhaus Institut  
Dr. Wolfgang Feist  
64283 Darmstadt  
Deutschland

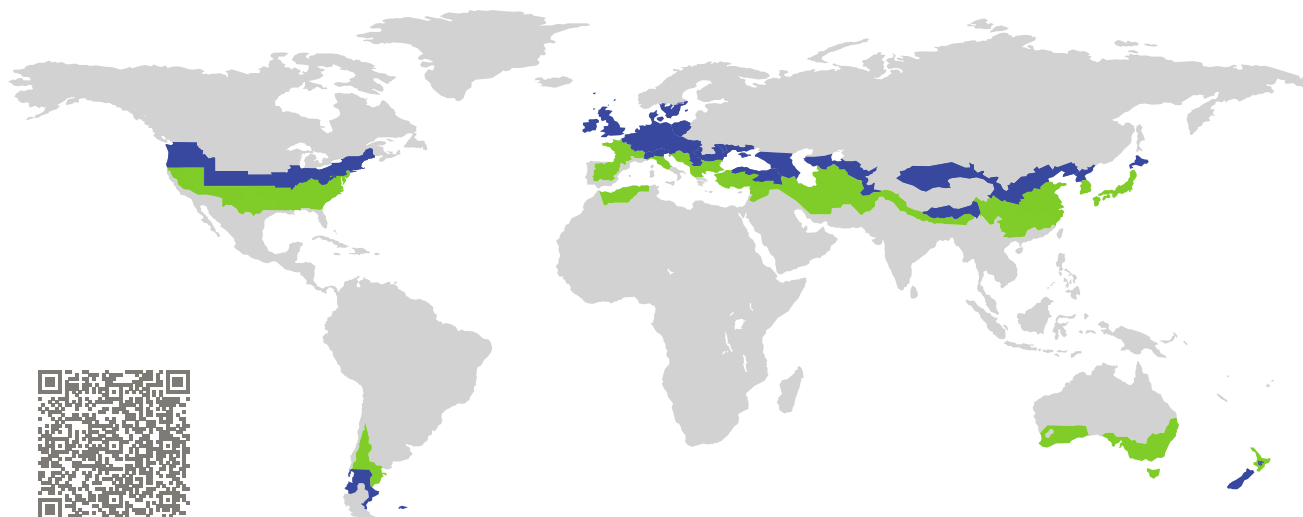

Kategorie: **Fenster System**  
Hersteller: **pro Passivhausfenster GmbH,  
Oberaudorf,  
Deutschland**  
Produktname: **smartwin solar**

**Folgende Kriterien für die kühl-gemäßigte Klimazone  
wurden geprüft**

Behaglichkeit  $U_W = 0,78 \leq 0,80 \text{ W}/(\text{m}^2 \text{ K})$   
 $U_{W,\text{eingebaut}} \leq 0,85 \text{ W}/(\text{m}^2 \text{ K})$   
mit  $U_g = 0,70 \text{ W}/(\text{m}^2 \text{ K})$

Hygiene  $f_{Rsi=0,25} \geq 0,70$   
Luftdichtheit  $Q_{100} = 0,24 \leq 0,25 \text{ m}^3/(\text{h m})$

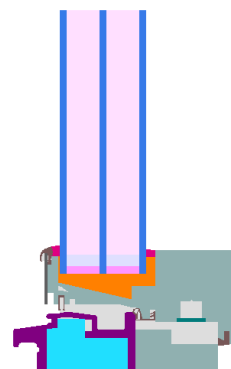

kühl-gemäßigtes Klima



**ZERTIFIZIERTE  
KOMPONENTE**

Passivhaus Institut

Passivhaus-  
Effizienzklasse

phE

phD

phC

phB

phA

[www.passiv.de](http://www.passiv.de)

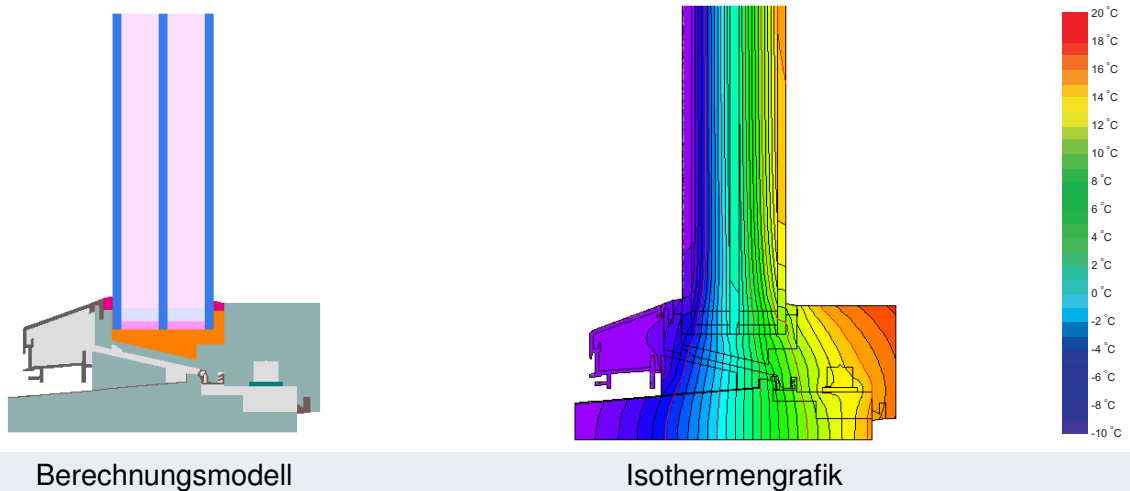

### Beschreibung

Holz-Aluminiumfensterrahmen (Tanne/Fichte 0,11 W/(mK)) mit Naturfaserdämmung, 0,040 W/(mK). Lastabtragung des Glases über spezielle Eckstücke. Die Kennwert der Luftdichtheit wurde an einer Kombination aus Festverglasung und Drehkipp-Flügel, Elementgröße 2,0m\*2,6 m ermittelt. Der Fenstereinbau wird individuell durch den Hersteller geplant. Glasstärke: 48 mm (4/18/4/18/4), Glaseinstand: 15 mm. Abstandhalter: SWISSPACER Ultimate.

### Erläuterung

















Die Fenster-U-Werte wurden für die Prüffenstergröße von 2,46 m × 1,48 m bei  $U_g = 0,70 \text{ W}/(\text{m}^2 \text{ K})$  berechnet. Werden höherwertige Verglasungen eingesetzt, verbessern sich die Fenster-U-Werte wie folgt:

Verglasung	$U_g =$	0,70	0,64	0,58	0,52	W/(m <sup>2</sup> K)
		↓	↓	↓	↓	
Fenster	$U_w =$	0,78	0,73	0,68	0,63	W/(m <sup>2</sup> K)

Transparente Bauteile werden abhängig von den Wärmeverlusten durch den opaken Teil in Effizienzklassen eingestuft. In diese Wärmeverluste gehen die Rahmen-U-Werte, die Rahmenbreiten, Glasrand und die Glasrandlängen ein. Ein ausführlicher Bericht über die im Rahmen der Zertifizierung durchgeführten Berechnungen ist beim Hersteller erhältlich.

Das Passivhaus Institut hat weltweite Komponentenanforderungen für sieben Klimazonen definiert. Grundsätzlich können Komponenten, die für Klimazonen mit höheren Anforderungen zertifiziert sind, auch in Klimazonen mit geringeren Anforderung eingesetzt werden. Es kann wirtschaftlich sinnvoll sein, in einer Klimazone eine thermisch höherwertige Komponente, die für eine Klimazone mit strengeren Anforderungen zertifiziert wurde, einzusetzen.

Weitere Informationen zur Zertifizierung sind unter [www.passiv.de](http://www.passiv.de) und [www.passipedia.de](http://www.passipedia.de) verfügbar.

Rahmen-Kennwerte		Rahmenbreite $b_f$ mm	Rahmen- $U$ -Wert $U_f$ W/(m <sup>2</sup> K)	Glasrand- $\Psi$ -Wert $\Psi_g$ W/(m K)	Temperaturfaktor $f_{RSI=0,25}$ [-]
Pfosten fest	(0M1) 	110	0,69	0,028	0,71
Riegel fest	(0T1) 	110	0,74	0,027	0,70
Pfosten Flügel	1 (1M1) 	80	0,84	0,027	0,71
Pfosten Flügel	1 (1M2) 	110	0,78	0,027	0,71
Riegel Flügel	1 (1T1) 	80	0,83	0,027	0,70
Riegel Flügel	1 (1T2) 	110	0,83	0,028	0,70
Pfosten Flügel	2 (2M1) 	110	0,75	0,026	0,72
Riegel Flügel	2 (2T1) 	110	0,81	0,026	0,72
Riegel Flügel	2 (2T2) 	124	0,81	0,026	0,71
Unten fest	(FB1) 	62	0,68	0,028	0,71
Oben fest	(FH1) 	62	0,67	0,027	0,72
Seitlich fest	(FJ1) 	62	0,67	0,027	0,72
Stulp	(FM1) 	92	0,76	0,026	0,72
Unten	(OB1) 	62	0,84	0,026	0,71
Oben	(OH1) 	62	0,77	0,026	0,72
Seitlich	(OJ1) 	62	0,77	0,026	0,72
Schwelle	(OT1) 	67	0,91	0,027	0,70

Abstandhalter: MULTITECH G

Sekundärdichtung: Polysulfid



### Pfosten fest

$$b_f = 110 \text{ mm}$$
$$U_f = 0,69 \text{ W}/(\text{m}^2 \text{ K})$$
$$\Psi_g = 0,028 \text{ W}/(\text{m K})$$
$$f_{Rsi} = 0,71$$

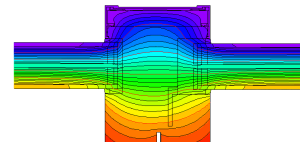
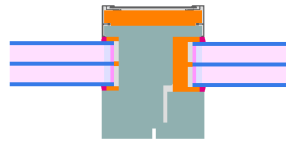

### Riegel fest

$$b_f = 110 \text{ mm}$$
$$U_f = 0,74 \text{ W}/(\text{m}^2 \text{ K})$$
$$\Psi_g = 0,027 \text{ W}/(\text{m K})$$
$$f_{Rsi} = 0,70$$

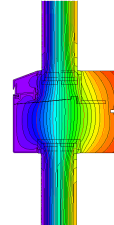
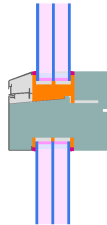

### Pfosten 1 Flügel

$$b_f = 80 \text{ mm}$$
$$U_f = 0,84 \text{ W}/(\text{m}^2 \text{ K})$$
$$\Psi_g = 0,027 \text{ W}/(\text{m K})$$
$$f_{Rsi} = 0,71$$

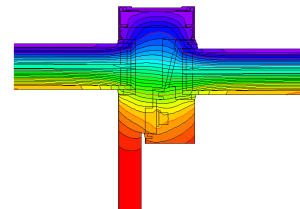
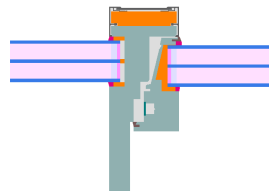

### Pfosten 1 Flügel

$$b_f = 110 \text{ mm}$$
$$U_f = 0,78 \text{ W}/(\text{m}^2 \text{ K})$$
$$\Psi_g = 0,027 \text{ W}/(\text{m K})$$
$$f_{Rsi} = 0,71$$

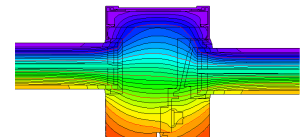
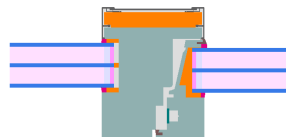

### Riegel 1 Flügel

$$b_f = 80 \text{ mm}$$
$$U_f = 0,83 \text{ W}/(\text{m}^2 \text{ K})$$
$$\Psi_g = 0,027 \text{ W}/(\text{m K})$$
$$f_{Rsi} = 0,70$$

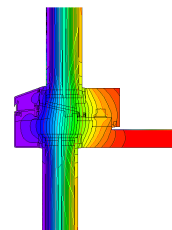
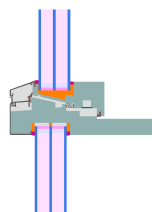



### Riegel 1 Flügel

$$b_f = 110 \text{ mm}$$
$$U_f = 0,83 \text{ W}/(\text{m}^2 \text{ K})$$
$$\Psi_g = 0,028 \text{ W}/(\text{m K})$$
$$f_{Rsi} = 0,70$$

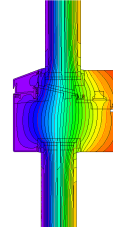
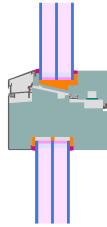

### Pfosten 2 Flügel

$$b_f = 110 \text{ mm}$$
$$U_f = 0,75 \text{ W}/(\text{m}^2 \text{ K})$$
$$\Psi_g = 0,026 \text{ W}/(\text{m K})$$
$$f_{Rsi} = 0,72$$

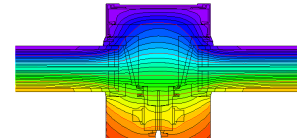
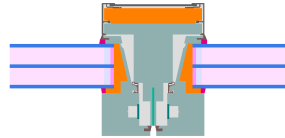

### Riegel 2 Flügel

$$b_f = 110 \text{ mm}$$
$$U_f = 0,81 \text{ W}/(\text{m}^2 \text{ K})$$
$$\Psi_g = 0,026 \text{ W}/(\text{m K})$$
$$f_{Rsi} = 0,72$$

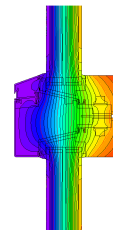
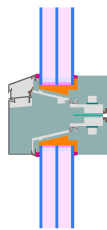

### Riegel 2 Flügel

$$b_f = 124 \text{ mm}$$
$$U_f = 0,81 \text{ W}/(\text{m}^2 \text{ K})$$
$$\Psi_g = 0,026 \text{ W}/(\text{m K})$$
$$f_{Rsi} = 0,71$$

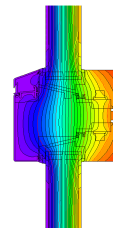
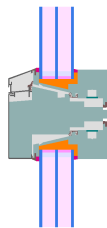

### Unten fest

$$b_f = 62 \text{ mm}$$
$$U_f = 0,68 \text{ W}/(\text{m}^2 \text{ K})$$
$$\Psi_g = 0,028 \text{ W}/(\text{m K})$$
$$f_{Rsi} = 0,71$$

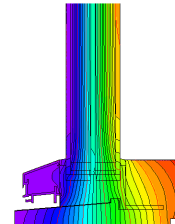
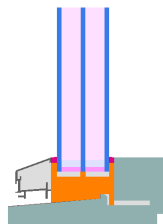



### Oben fest

$$b_f = 62 \text{ mm}$$
$$U_f = 0,67 \text{ W}/(\text{m}^2 \text{ K})$$
$$\Psi_g = 0,027 \text{ W}/(\text{m K})$$
$$f_{Rsi} = 0,72$$

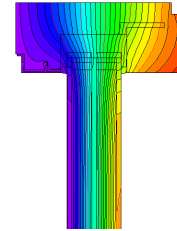
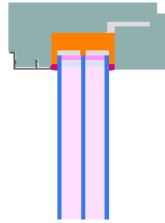

### Seitlich fest

$$b_f = 62 \text{ mm}$$
$$U_f = 0,67 \text{ W}/(\text{m}^2 \text{ K})$$
$$\Psi_g = 0,027 \text{ W}/(\text{m K})$$
$$f_{Rsi} = 0,72$$

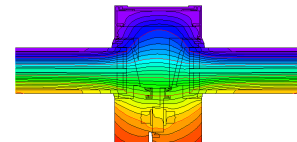
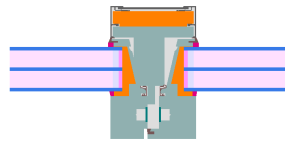

### Stulp

$$b_f = 92 \text{ mm}$$
$$U_f = 0,76 \text{ W}/(\text{m}^2 \text{ K})$$
$$\Psi_g = 0,026 \text{ W}/(\text{m K})$$
$$f_{Rsi} = 0,72$$

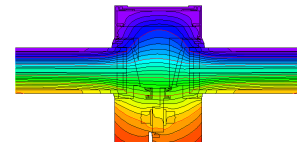
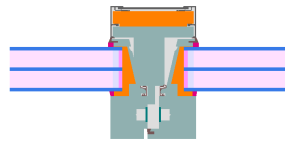

### Unten

$$b_f = 62 \text{ mm}$$
$$U_f = 0,84 \text{ W}/(\text{m}^2 \text{ K})$$
$$\Psi_g = 0,026 \text{ W}/(\text{m K})$$
$$f_{Rsi} = 0,71$$

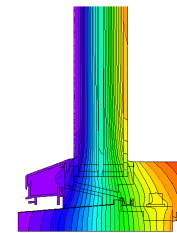
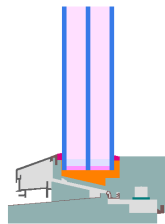

### Oben

$$b_f = 62 \text{ mm}$$
$$U_f = 0,77 \text{ W}/(\text{m}^2 \text{ K})$$
$$\Psi_g = 0,026 \text{ W}/(\text{m K})$$
$$f_{Rsi} = 0,72$$

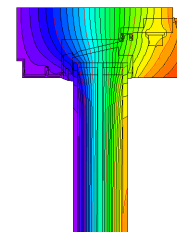
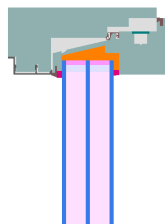



### Seitlich

$$b_f = 62 \text{ mm}$$
$$U_f = 0,77 \text{ W}/(\text{m}^2 \text{ K})$$
$$\Psi_g = 0,026 \text{ W}/(\text{m K})$$
$$f_{Rsi} = 0,72$$

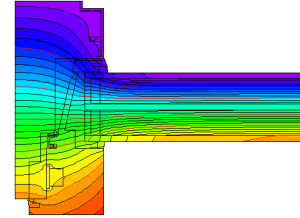
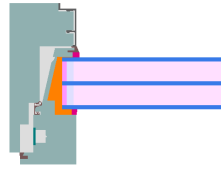

### Schwelle

$$b_f = 67 \text{ mm}$$
$$U_f = 0,91 \text{ W}/(\text{m}^2 \text{ K})$$
$$\Psi_g = 0,027 \text{ W}/(\text{m K})$$
$$f_{Rsi} = 0,70$$

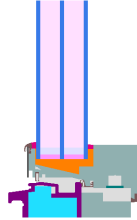

# Geprüfte Einbausituationen

**Betonschalungsstein (fest verglast)**

$U_{Wand} = 0,15 \text{ W}/(\text{m}^2 \text{ K})$

Exterior plaster 1.0 W/(mK)  
EPS 0.035 W/(mK)  
Concrete 2.3 W/(mK)  
EPS 0.035 W/(mK)  
Interior plaster 0.57 W/(mK)

Insulation 0.040 W/(mK)

$\Psi_{\text{einbau}}$	W/(m K)
Oben	0,013
Links	0,013
Rechts	0,013
Unten	0,024

$U_{W,\text{eingebaut}} = 0,82 \text{ W}/(\text{m}^2 \text{ K})$

**Betonschalungsstein (öffnenbar)**

$U_{Wand} = 0,15 \text{ W}/(\text{m}^2 \text{ K})$

Exterior plaster 1.0 W/(mK)  
EPS 0.035 W/(mK)  
Concrete 2.3 W/(mK)  
EPS 0.035 W/(mK)  
Interior plaster 0.57 W/(mK)

Insulation 0.040 W/(mK)

$\Psi_{\text{einbau}}$	W/(m K)
Oben	0,013
Links	0,013
Rechts	0,013
Unten	0,026

$U_{W,\text{eingebaut}} = 0,82 \text{ W}/(\text{m}^2 \text{ K})$

**Holzleichtbau (fest verglast)**

$U_{Wand} = 0,13 \text{ W}/(\text{m}^2 \text{ K})$

Exterior plaster 1.0 W/(mK)  
Wood fibre board 0.050 W/(mK)  
Cellulose 0.040 W/(mK)  
OSB-board 0.13 W/(mK)  
Insulation 0.040 W/(mK)  
Plasterboard 0.25 W/(mK)

$\Psi_{\text{einbau}}$	W/(m K)
Oben	0,015
Links	0,015
Rechts	0,015
Unten	0,018

$U_{W,\text{eingebaut}} = 0,82 \text{ W}/(\text{m}^2 \text{ K})$

**Holzleichtbau (öffnenbar)**

$U_{Wand} = 0,13 \text{ W}/(\text{m}^2 \text{ K})$

Exterior plaster 1.0 W/(mK)  
Wood fibre board 0.050 W/(mK)  
Cellulose 0.040 W/(mK)  
OSB-board 0.13 W/(mK)  
Insulation 0.040 W/(mK)  
Plasterboard 0.25 W/(mK)

$\Psi_{\text{einbau}}$	W/(m K)
Oben	0,015
Links	0,015
Rechts	0,015
Unten	0,020

$U_{W,\text{eingebaut}} = 0,82 \text{ W}/(\text{m}^2 \text{ K})$

**Wärmedämmverbundsystem (WDVS) (fest verglast)**

$U_{Wand} = 0,13 \text{ W}/(\text{m}^2 \text{ K})$

Exterior plaster 1.0 W/(mK)  
EPS 0.035 W/(mK)  
Adhesive 0.70 W/(mK)  
Sand-lime brick 1.0 W/(mK)  
Interior plaster 0.57 W/(mK)

$\Psi_{\text{einbau}}$	W/(m K)
Oben	0,017
Links	0,017
Rechts	0,017
Unten	0,019

$U_{W,\text{eingebaut}} = 0,82 \text{ W}/(\text{m}^2 \text{ K})$

**Wärmedämmverbundsystem (WDVS) (öffnenbar)**

$U_{Wand} = 0,13 \text{ W}/(\text{m}^2 \text{ K})$

Exterior plaster 1.0 W/(mK)  
EPS 0.035 W/(mK)  
Adhesive 0.70 W/(mK)  
Sand-lime brick 1.0 W/(mK)  
Interior plaster 0.57 W/(mK)

$\Psi_{\text{einbau}}$	W/(m K)
Oben	0,018
Links	0,018
Rechts	0,018
Unten	0,022

$U_{W,\text{eingebaut}} = 0,83 \text{ W}/(\text{m}^2 \text{ K})$



Wärmedämmverbundsystem (WDVS)  
Schwelle (öffnenbar)

$$U_1 = 0,13 \quad [\text{W}/(\text{m}^2 \text{K})]$$

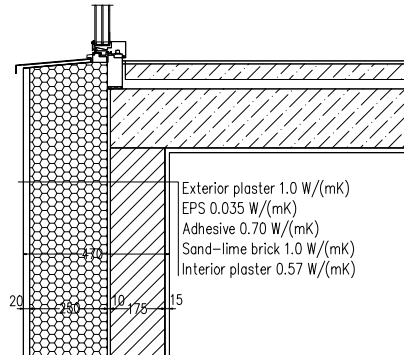

$$\Psi_{\text{einbau}} = 0,03 \text{ W}/(\text{m K})$$

